

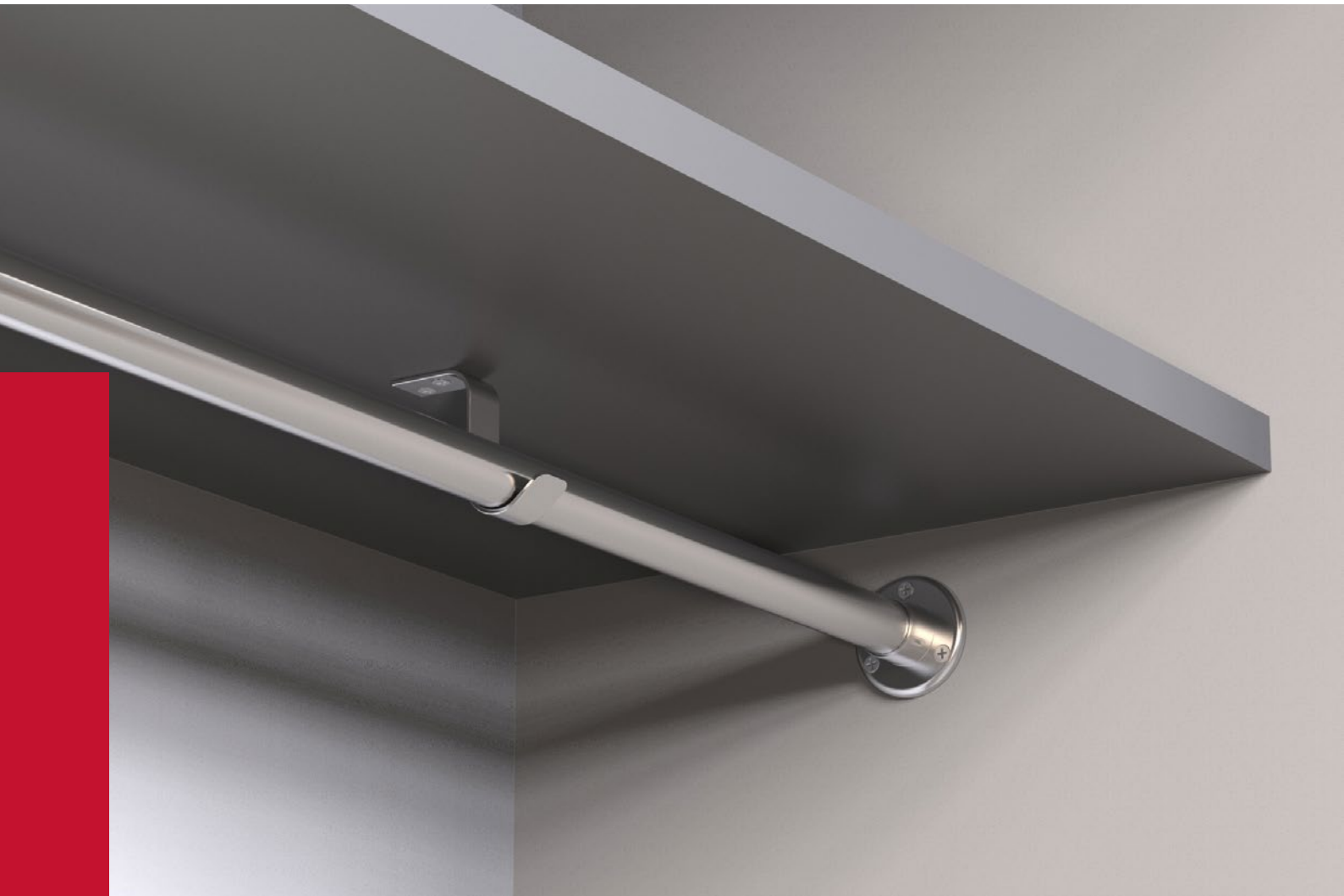

CLOSET RODS & FLANGES



SETTING THE STANDARD

Over 30 Years of Manufacturing Innovation and Custom Design

Standard Metal Hardware Manufacturing Ltd. is a leading manufacturer of commercial and custom architectural door hardware in North America. Since 1989, we have been manufacturing from our facility in Toronto, Canada, committed to setting the standard for innovation and design.

We work closely with architects and designers around the world to create some of the most intricate and visually appealing custom architectural door hardware products using a variety of materials, styles and finishes. We supply a network of distributors across North America with an extensive product line including door pulls, grab bars, kick plates, door guards, door stops, patch locks, bolts, latches and more.











Our custom manufacturing is done in-house and is our way of controlling our production to guarantee that the products meet the highest level of quality and craftsmanship. Our products have been used on thousands of recognized building projects including hotels, airports, hospitals, schools, retail, office and other institutional buildings.

It is our vision to deliver door hardware solutions that enhance the appearance, security and value of every building project. Share your vision with us and we will help you bring it to life.















FINISHES CHART

NBHA	BHMA	MATERIALS	FINISHES
3	605	BR, BRZ, STL, SS, ZN	BRIGHT BRASS, CLEAR LACQUERED 
4	606	BR, BRZ, STL, SS, ZN	SATIN BRASS, CLEAR LACQUERED 
5	609	BR, BRZ, STL, SS, ZN	SATIN BRASS, OXIDIZED AND RELIEVED (ANTIQUED) 
9	611	BR, BRZ, STL, SS, ZN	BRIGHT BRONZE, CLEAR LACQUERED 
10	612	BR, BRZ, STL, SS, ZN	SATIN BRONZE, CLEAR LACQUERED 
10B	613	BR, BRZ, STL, SS, ZN	SATIN BRONZE, OXIDIZED AND OIL RUBBED 
10BE	613E	BR, BRZ, STL, SS, ZN	SATIN BRONZE, OXIDIZED AND OIL RUBBED EQUIVALENT 
14	618	BR, BRZ, STL, SS, ZN	BRIGHT NICKEL 
15	619	BR, BRZ, STL, SS, ZN	SATIN NICKEL 
19	671	BR, BRZ, AL, STL, SS, ZN	FLAT BLACK POWDER COATED 

MATERIALS LEGEND: Brass = BR | Bronze = BRZ | Aluminum = AL | Steel = STL | Stainless Steel = SS



FINISHES CHART

NBHA	BHMA	MATERIALS	FINISHES
20L	623	BR, BRZ, STL, SS, ZN	BRONZE, OXIDIZED LIGHT AND LACQUERED 
20D	624	BR, BRZ, STL, SS, ZN	BRONZE, OXIDIZED DARK AND LACQUERED 
26	625	BR, BRZ, STL, SS, ZN	BRIGHT CHROMIUM 
26D	626	BR, BRZ, STL, SS, ZN	SATIN CHROMIUM 
28	628	AL	SATIN ALUMINUM, ANODIZED CLEAR 
K29	711	AL	SATIN ALUMINUM, ANODIZED BLACK 
32	629	BR, BRZ, STL, SS, ZN	BRIGHT STAINLESS STEEL 
32D	630	BR, BRZ, STL, SS, ZN	SATIN STAINLESS STEEL 
34		BR, BRZ, AL, STL, SS, ZN	GRAPHITE NICKEL POWDER COAT 
P	600	BR, BRZ, AL, STL, SS, ZN	PRIMED FOR PAINT
PC		BR, BRZ, AL, STL, SS, ZN	POWDER COAT (STANDARD & CUSTOM COLOURS AVAILABLE) 

| Zinc = ZN



CLOSET RODS & FLANGES

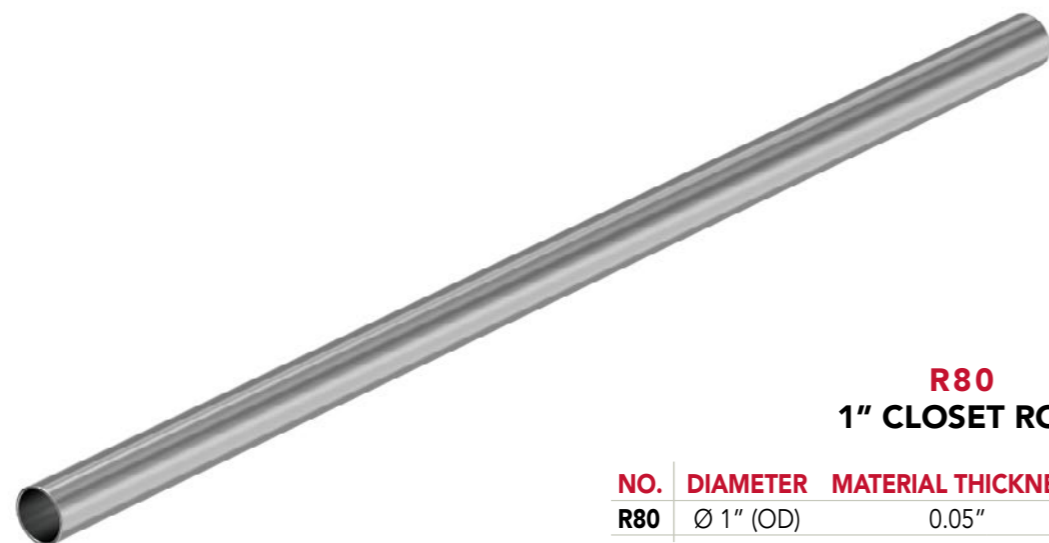

R80
1" CLOSET ROD

NO.	DIAMETER	MATERIAL THICKNESS	LENGTH
R80	Ø 1" (OD)	0.05"	SPECIFY (96" MAX)

FEATURED FINISHES: Flat Black (19), Satin Stainless (32D)
FINISHES: Standard & Custom Available (See Pages 12 & 13)
MATERIALS: Brass, Stainless Steel, Steel

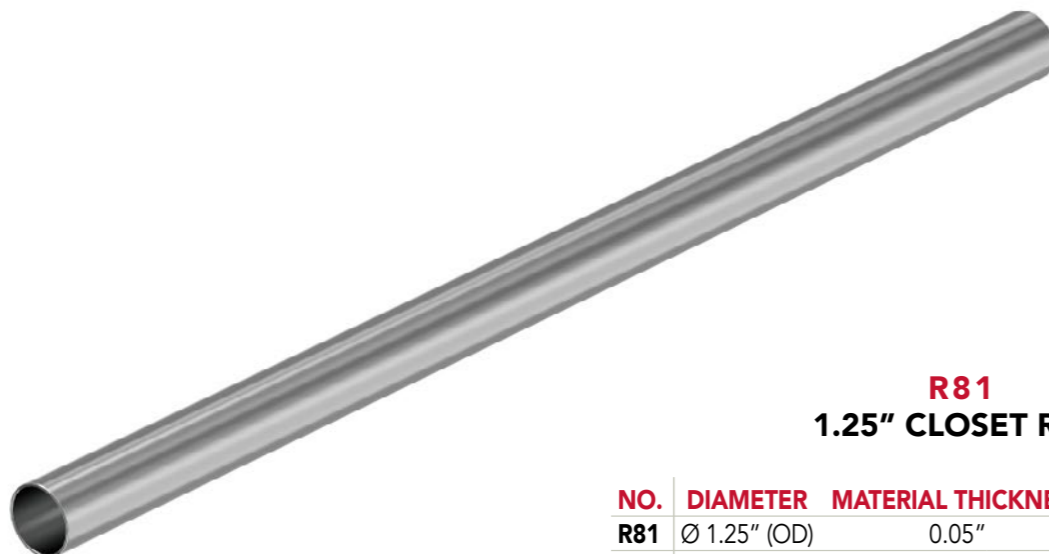

R81
1.25" CLOSET ROD

NO.	DIAMETER	MATERIAL THICKNESS	LENGTH
R81	Ø 1.25" (OD)	0.05"	SPECIFY (96" MAX)

FEATURED FINISHES: Flat Black (19), Satin Stainless (32D)
FINISHES: Standard & Custom Available (See Pages 12 & 13)
MATERIALS: Brass, Stainless Steel, Steel



CLOSET RODS & FLANGES



R82
ROD SUPPORT

NO.	HEIGHT
R82	2.5"

FEATURED FINISHES: Flat Black (19), Satin Chrome (26D)
FINISHES: Standard & Custom Available (See Pages 12 & 13)
MATERIAL: Stainless Steel



R83
1" CLOSET ROD FLANGE

NO.	DIAMETER
R83	Ø 1" ID

FEATURED FINISHES: Flat Black (19), Satin Chrome (26D)
FINISHES: Standard & Custom Available (See Pages 12 & 13)
MATERIAL: Zinc Die Cast



R84
1.25" CLOSET ROD FLANGE

NO.	DIAMETER
R84	Ø 1.25" ID

FEATURED FINISHES: Flat Black (19), Satin Chrome (26D)
FINISHES: Standard & Custom Available (See Pages 12 & 13)
MATERIAL: Zinc Die Cast

